

Data Sheet

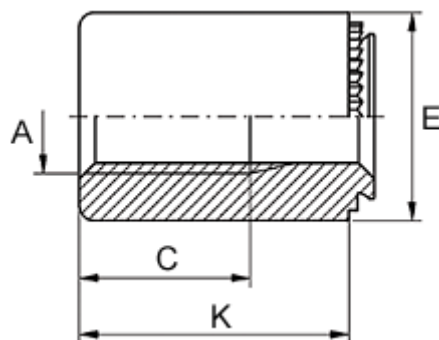

Article number: 12525800040500
Description: KLEE-coil 525 800 040.500
M4 Stainless 1.4305

Measures



Female thread A	= M4
Height K	= 25
Min distance to edge	= 4.0
Outer diameter E	= 8
Plate thickness	= 0.8 to 1.0
Recommended bore diameter +0.05	= 5.00
Thread length	= 8.0